

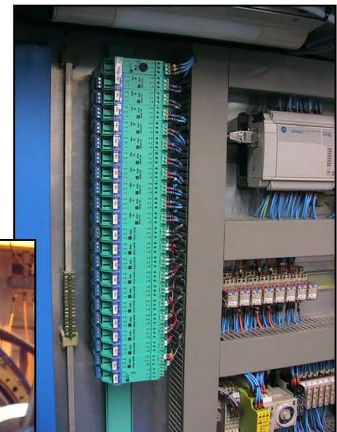

Pandalin UK Limited

Our Services Include:

- ✓ **Software Solutions & Systems Integration**
- ✓ **Design & Build of Control Systems and Panels**
- ✓ **Automation & Control System Consultants**
- ✓ **Engineering & CAD Services**
- ✓ **Electrical Services & Installations**
- ✓ **Testing & Commissioning**
- ✓ **Breakdown Service & Support**

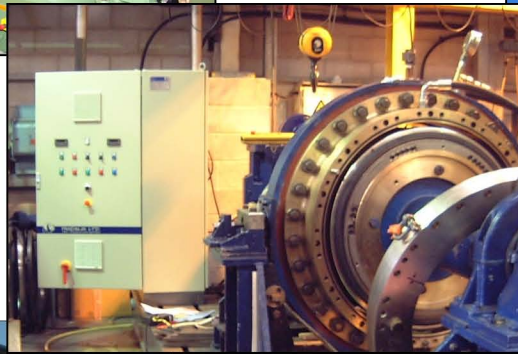

Keeping Industry in Control



Pandalin UK Limited
Unit 10 Fernacre Business Park
Budds Lane
Romsey
SO51 0HA
United Kingdom

☎ **+44 (0) 1794 519 000**

📄 **+44 (0) 1794 528360**

✉ **info@pandalin.com**

🌐 **www.pandalin.com**

Pandalin UK can offer a flexible range of electrical services and products:

◆ **Complete control system solutions including:**

- * Electrical, Instrumentation and Pneumatic control panels, cabinets & stations
- * Tailor-made PLC, HMI & SCADA packages
- * AC/DC drive solutions and motor control
- * Positioning and motion control including servos and linear drives
- * Motor Control Centres (MCC) and LV Power distribution switchboards
- * Certified hazardous area & Intrinsically Safe control panels



◆ **Temperature control and monitoring systems**

◆ **Electrical installations of all types of machinery**

◆ **Modification and servicing of existing control systems and panels**

◆ **Machinery breakdown service or maintenance support.**

◆ **Engineering services including Consultation, CAD services, Verification, Testing and Commissioning of new and existing installations.**

◆ **Global services and conformities**

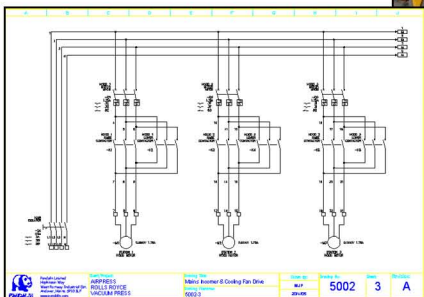

Pandalin UK will design and build to conform to global standards and quality guidelines such as:

- ✓ **IEC 60204 - Safety of Machines Directive**
- ✓ **IEC 60439 - The Low Voltage Directive**
- ✓ **BS 7671 – 16th Edition IEE Wiring Regulations**
- ✓ **The Electromagnetic Compatibility (EMC) Directive**
- ✓ **ATEX Directive - Equipment intended for use in Potentially Explosive Atmospheres**
- ✓ **CE Marking and Certification**
- ✓ **Good Automated Manufacturing Practice (GAMP)**

Who have we worked for and can we work for you?
 Well, the experience and expertise within Pandalin UK expands throughout a vast range of industrial sectors and manufacturing process's including:

- Cable and Wire Manufacturing
- Plastics Extrusion
- Furnace & Metal Alloy Casting
- Pharmaceutical
- Petrochemical (Onshore & Offshore)
- Gas & Chemical Production
- Water and Waste Water Treatment
- Test Houses and Laboratories
- Food & Beverage
- Filtration
- Aerospace
- Automotive
- Tobacco
- Cement
- Feed Mills
- Environmental
- MoD
- Marine
- General Manufacturing

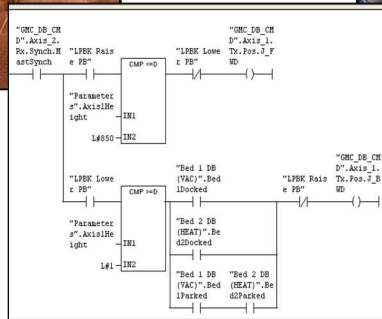
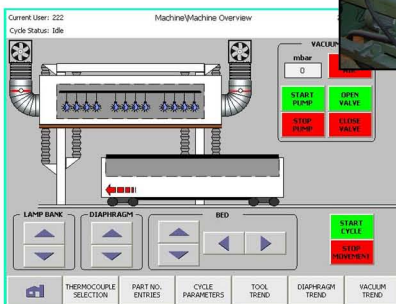
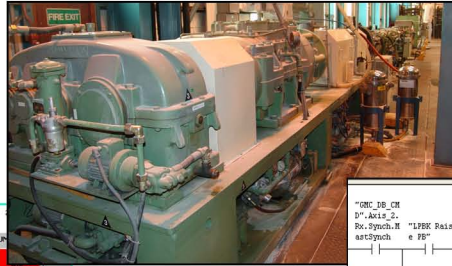

With a wealth of knowledge and experience in all types of machinery, process's and installations whether its within a bespoke or specialist sector, Pandalin UK can provide complete turnkey solutions and services to meet your needs and requirements.

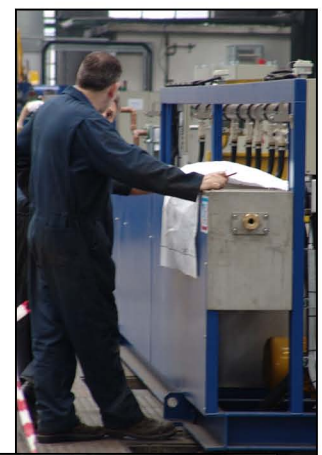
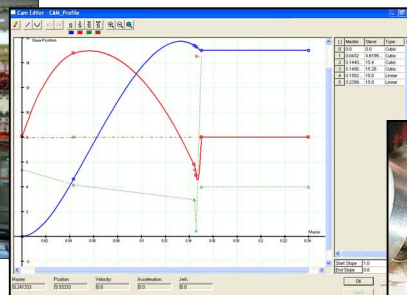

Pandalin UK can provide support and solutions for most of the market leaders including:

- **Siemens**
- **Rockwell Automation (Allen Bradley)**
- **Schneider Electric**
- **Mitsubishi**
- **Omron**
- **Parker SSD (Eurotherm)**
- **B&R Automation**





PANDALIN UK

**Unit 10 Fernacre Business Park
Budds Lane
Romsey
SO51 0HA**

United Kingdom

Tel. +44 (0) 1794 519 000

Fax. +44 (0) 1794 528360

Email. info@pandalin.com

Please visit our website at **www.pandalin.com**